



Our Thanks, The CB Story, and Customer Assistance

75 All Road

Wireless Recreational CB Radio with Digital Noise Cancellation



Owners Manual

Thank you for purchasing the Cobra 75 All Road Wireless Recreational CB Radio. Properly used, this CB radio will give you many years of reliable service.

Citizens Band Radio History

Invented by Al Gross in 1945, the CB radio originally served as a method of communication for troops during World War II. After the war, Gross worked to make two-way radios a way of communication for personal use and the CB radio service was established by law in the U.S. in 1949. It wasn't until the 1970s that technology advanced and the CB market caught on as a method of communication between drivers to report police speed traps and road hazards.

The Citizens Band Radio Service consists of 40 channel frequencies that are mostly 10 kHz apart. Transmitter power is limited to 4 watts in the US, and range can vary depending on the terrain and quality of the product.

Currently, the Citizens Band service does not require a license for operation, regardless of age, as long as the rules of operation established by the Federal Communication Commission (FCC) are followed.

Petition For FCC Part 65 Rule Changes

In 2016, Cobra petitioned the FCC to revise Part 95 rules to allow CB radios to use frequency modulation (FM). Cobra contended that FM offers improved speech quality and lower noise interference, which improves the standard of two-way radios and is a benefit to the customer.

Through the direct efforts of Cobra Electronics and the enthusiastic support from loyal customers and the distribution network, the FCC granted the request and in 2021, Part 95 officially was updated to include FM as an option for two-way radio use.

Today, thanks to Cobra Electronics' petitions to improve the quality of the Citizens Band Radio Service, users can enjoy the benefits of CB radio communication in a range of industries.

Customer Assistance



Customer Assistance

Should you encounter any problems with this product, not understand its features, menu or installation, please refer to the this owner's manual. If you require further assistance, after reading this manual, we are here to help:

Service, Orders & Product Questions

For service, orders, product questions and service hours please call 800-543-1608 or go to www.cobra.com.

For Assistance Outside the U.S.A.

Contact Your Local Dealer

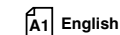

English

For more information or to order any of our products, please visit our website: www.cobra.com

© 2023 Cobra Electronics Corporation www.cobra.com

Cobra®, and the snake design are registered trademarks of Cobra Electronics Corporation, USA. Cobra Electronics Corporation™ is a trademark of Cobra Electronics Corporation, USA.



Product Features

Handset

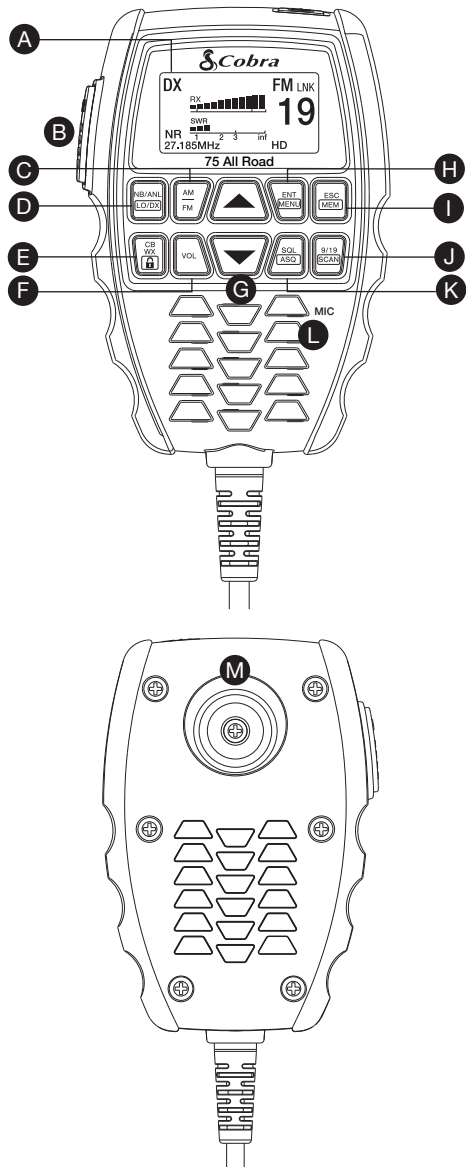

Product Features

Transceiver (CB Radio)

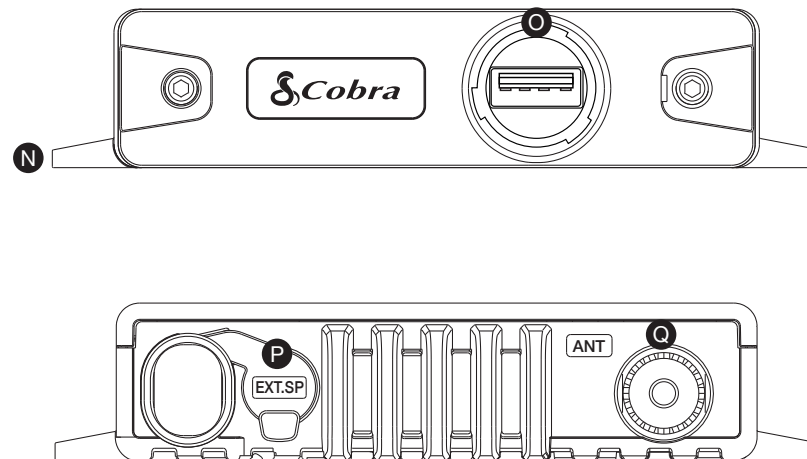

- A. LCD Display
- B. Push-To-Talk (PTT)
- C. AM/FM
- D. NB/ANL/LO-DX
- E. CB/Weather/Lock
- F. Volume
- G. Up / Down Buttons
- H. Enter/Menu
- I. Escape / Memory
- J. Channel 9/19/Scan
- K. Squelch/Auto Squelch
- L. Microphone
- M. Removable Hanger Post
- N. Mounting Tabs
- O. USB Port with Waterproof Cover
- P. External Speaker Port with Waterproof Cover
- Q. Antenna Port



Contents

Our Thanks, The CB Story and Customer Assistance	A1
The Citizens Band Story	A1
Customer Assistance	A1
Product Features	A2
Included in the Package	2
Installation and Start-Up	
IP Rating	3
Planning the 75 All Road Installation	3
Mounting the CB Transceiver (Black Box)	4
Connecting Wires	4
Installing the Handset Hanger	5
CB Antenna	5
Installing an Antenna	6
Installing an External Speaker	6
Operation	
Display	7
Powering the CB On and Off	8
Channel Control	8
Volume Control	8
Squelch Control (Levels OFF - 34)	8
Digital Noise Cancellation	8
Keypad Functions	9
Menus	10
Bluetooth®	10
Pairing a Bluetooth Headset	10
Pairing All Road Wireless PTT Button	10
Audio Path	11
VOX	11
VOX Level	12
VOX Delay	12
Time Out Timer	12
WX Alert	13
WX Alert Scan	13
WX Auto Scan	14
Display MHz	14
Auto Power	14
Backlight	15
Contrast	15
Key Tone	15
Audio Routing	16
TX NR	16
RX NR	17
Reset	17
Frequency Ranges	18
Specifications	19
Maintenance/Adjustment	20
Troubleshooting	21
Regulatory and Warning Statements	22
Limited Two-Year Warranty	24
Replacement Parts & Accessories	25
Need Help?	26



Included in the Package

All-in-One Handset



Transceiver or "Black Box" (CB Radio)

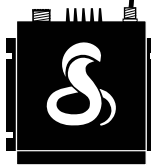

Waterproof USB Cover



Mounting Hardware

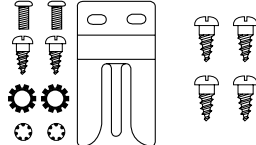

Hardwire Kit

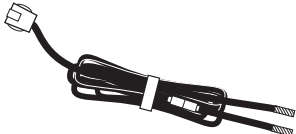

12 Volt Adapter

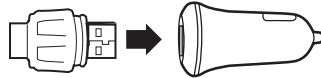

Quick Start Guide



IP Rating, Installation and Start-Up

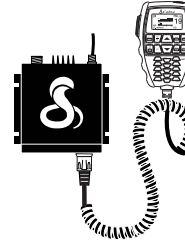

IP Rating

The 75 All Road components are IP66 rated, which means they are waterproof and dustproof when the handset and transceiver are connected and locked.

When the handset is disconnected from the transceiver, be sure to seal and protect the USB port with the waterproof cover that comes included. **

WARNING: If the USB port on the transceiver is left unprotected and is exposed to water or dirt, the unit is at risk of permanent damage and/or failure.



** **Lost the USB port cover?** Find a replacement waterproof cover on the CB Accessories page on cobra.com

Planning the 75 All Road Installation

The 75 All Road CB includes an all-in-one handset, which allows you to communicate, change settings and operate the CB. It also includes the CB transceiver, which connects wirelessly via Bluetooth® to the handset. This provides flexible powering, mounting, and communication options, so you can mount your 75 All Road CB radio anywhere inside your vehicle.

Before installing the 75 All Road CB, consider the power source you plan to use for the handset before selecting an installation location:

1. Handset to CB (transceiver)
2. Handset connected to the vehicle USB port
3. Handset connected to the power adapter (included) for connection with the vehicle's 12V power port

The handset is powered with a 5V USB connector, which can be plugged in and powered directly from any USB Type A port inside the vehicle or from the USB output on the front of the transceiver. This provides flexible powering options.

If you plan to connect the handset directly to the CB, you will need to consider a location closer to the handset.

By mounting the handset away from the transceiver, you can install the transceiver under a seat, in the trunk, or anywhere inside the vehicle.

NOTE: Do not mount under the hood, near heat ducts, in direct line of the car's heater or near gas and brake pedals.

Example 1

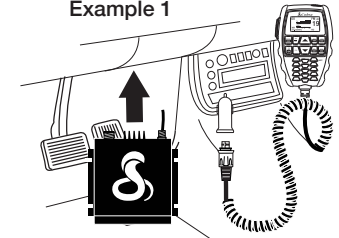

Example 2

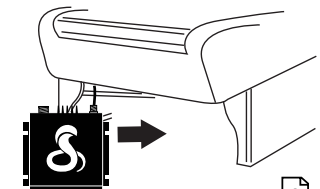

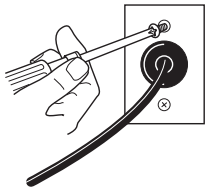
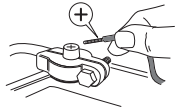
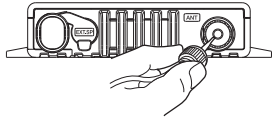
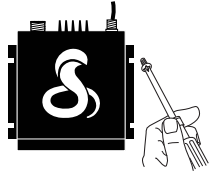
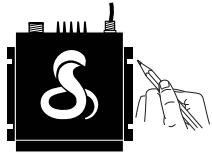

Mounting the CB Transceiver (Black Box)

1. Hold the Cobra 75 All Road black box in the exact location desired for mounting.
2. Using it as a template, mark the location for the mounting screws (included).

NOTE: Make certain that nothing will interfere with the installation of the mounting screws before drilling holes.

3. Drill and mount the black box as shown.

NOTE: Mounting the CB transceiver (Black Box) closer to the antenna will provide a better signal to the radio.

Connecting Wires

Using the 75 All Road CB requires antenna and hardwire installation.

1. Connect the antenna cable plug (see Installing an Antenna before connecting).
2. Install the provided hardware.
3. Connect the **red** wire (+) directly to the positive side of the battery or to a connection on the fuse box that is always on.
4. Connect the **black** wire (—) to the negative side of the car, usually the chassis. Any other location with good electrical contact (paint removed) will also work.

NOTE: You must use a CB antenna (sold separately) with this radio. Antenna options are available on cobra.com. Please check your vehicle's owner manual before installing and connecting the antenna and CB cables.



Installing the Handset Hanger

1. Hold the microphone hanger in the location desired for mounting.

NOTE: Make certain that nothing will interfere with the hanger's installation.

2. Using it as a template, mark the location for the mounting screws (included).

3. Drill and mount the microphone hanger.

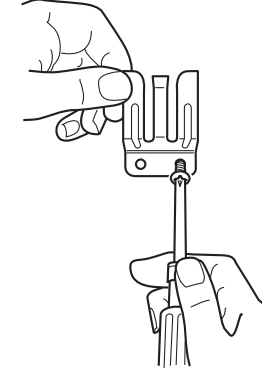
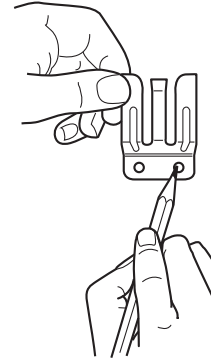

CB Antenna

Since the maximum allowable power output of the transmitter is limited by the FCC, the antenna is critical to maximize transmission distance. Only a properly matched antenna system will allow maximum power output. Cobra loaded type antenna models are highly recommended for most installations. Consult your Cobra dealer for further details, or call 800-543-1608 and speak to a Cobra representative. A standard antenna connector is provided on the transceiver for easy connection.

For optimum performance in passenger vehicles, the ideal antenna location is on the center of the roof. The second-best choice is on the center of the trunk (if available). Because many newer trucks feature fiberglass door skins, the outside mirror must be grounded to the chassis via a ground strap when the antenna is mounted on the mirror bracket.

3-way combination antennas are also available which allow operation of all three bands (AM-FM & CB), using a single antenna. However, this type of antenna usually results in less than normal transmit and receive range when compared to a standard-type "Single Band" CB antenna.

Cobra offers CB antenna and mounting solutions that can be purchased online. Please visit www.cobra.com, or if you'd like to speak with an expert, please call 800-543-1608 and our Customer Care Group can assist.



Installation and Start-Up

Installing An Antenna

Be sure the antenna is properly connected to the radio before transmitting. Prolonged transmitting without an antenna, or use of a poorly matched antenna, could cause damage to the CB.

For the most reliable operation and maximum range, Cobra recommends using a vertically polarized, quarter wavelength whip antenna. Shorter, loaded-type whips are adequate when maximum range is not required.

NOTE: Mobile installations (cars, trucks, boats, etc) should be made only with a non-directional antenna system.

- A standard antenna connector (Type S0-239) is provided on the black box for easy connection to a standard PL-259 cable termination.
- Cobra antenna models are recommended; order directly from Cobra at www.cobra.com or contact your local Cobra dealer.
- For maximum efficiency in boat installations, a ground plane is required, unless the vessel has a steel hull.

Consult your CB dealer for information regarding an adequate grounding system.

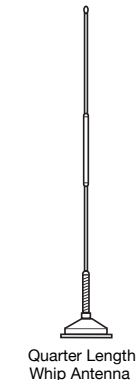

Quarter Length Whip Antenna

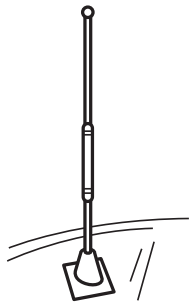

Shorter Length Whip Antenna

Installing an External Speaker

1. Mount external speaker in desired location.
2. Plug into the back of the CB transceiver.

The external speaker should have 4-8 Ohms impedance and be able to handle at least 4 Watts.

NOTE: The external speaker is a Bridge Tied Load (BTL) design. Do not short the speaker wires to ground as it may damage the speaker amplifier.

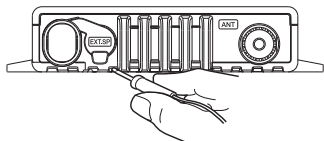

Operation

Display

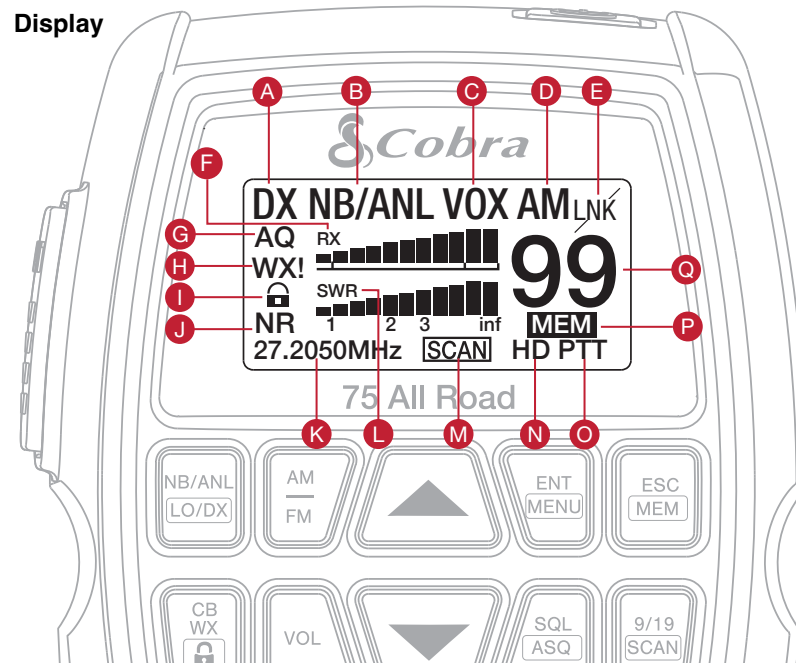

- | | |
|---|---------------------------------------|
| A. DX / LO | J. DSP enabled ON |
| B. NB, ANL, NB / ANL | K. Channel Frequency |
| C. VOX | L. SWR Meter |
| D. AM / FM | M. Channel Scan Activated |
| E. Bluetooth Connection Indicator* | N. Audio Path |
| F. RX / TX Meter** | O. Wireless PTT Button enabled |
| G. Auto Squelch | P. Memory Channel Indicator |
| H. Weather Alert Icon | Q. Channel Number |
| I. Key Lock Icon | |



*When disconnected the LNK icon will show a strikethrough (a line through the icon)

**TX Meter appears when using PTT





Getting Started:

Powering the CB On and Off

1. To turn on your radio, press and release the POWER button  on the handset. Wait for the handset to establish the wireless connection with the black box.
2. To power off the radio, press and hold the POWER button  until the LCD display turns off.

Channel Control



1. Press the UP key to increase the channel number.
2. Press the DOWN key to decrease the channel number.
3. Push and hold the UP  or DOWN  key to quickly scroll through the channel selection.

Volume Control

1. Press and release the VOL (Volume) button.
2. Use the UP  or DOWN  to adjust the volume.



Squelch Control (Levels OFF - 34)

The squelch control filters out weaker radio signals that cause noise, and only allows stronger signals to be heard.

1. To adjust the squelch level, press and release the SQ/ASQ button.
2. Use the UP  or DOWN  arrow keys to adjust Squelch Level.



Digital Noise Cancellation

Your 75 All Road CB has Digital Signal Processing (DSP) that reduces background noise and produces clear sound while communicating. This is pre-set to Level 01 (max noise reduction) and shows as **NR** on the LCD display in both RX and TX transmit modes. DSP can be adjusted in the Menu Settings:

1. Press and hold the Menu button.
2. Scroll Menu options and select **TX NR** to adjust noise reduction level when in transmit mode or **RX NR** to adjust the noise reduction level while in receive mode.
3. Use the UP  or DOWN  arrows to adjust the DSP level (Levels 01 - 05, level 05 provides max noise reduction). You can also select OFF if DSP is not desired.



Keypad Functions

Button	Function Definition	What it does
NB/ANL	Noise/Sound Filters: NB = Noise Blanker ANL = Automatic Noise Limiter NB/ANL = Combination	These settings help reduce noise from the engine and vehicle electronics.
LO/DX	Replacement for RF Gain Control: LO = Local DX = Distance	These settings provide receiver RF Gain Control. Press and hold the LO/DX button to select 'Local'. Press and hold LO/DX to select DX.
AM/FM	Radio Modes: AM = Amplitude Modulation FM = Frequency Modulation	Indicates AM or FM modes. Press and release the AM/FM button to change between modes.
Arrow Keys UP and DOWN	 Up Arrow = Up  Down Arrow = Down	These are the primary keys for channel changes and setting adjustments.
ENT/MENU	ENTER/MENU	Used to make selections in the MENU. Press and hold this key to get to and select MENU options.
ESC/MEM	ESC = "Back" button MEM = Memory	ESC (Escape) takes you back one level when navigating the MENU. Press and hold MEM when tagging channels for Memory Scan.
CB/WX/LOCK	CB = CB Mode WX = Weather Mode  = Key Lock Function	Toggle between CB and Weather modes. Press and hold for the Key Lock function.
VOL	Volume Control	Adjust volume setting.
SQL/ASQ	Squelch/Auto Squelch	Press to adjust Squelch (Level OFF - 34). Press and hold to access Auto Squelch - (Levels OFF - 09).
9/19/SCAN	Instant Channels 9 & 19 Scan+Channels	Press and release to access Channel 9 and Channel 19. Press and hold to scan all channels. Press and hold a second time to scan all MEM tagged channels. Press and hold a third time to exit scan.

For additional setting options & defaults please download the electronic manual from www.cobra.com



Bluetooth®

The Bluetooth® Menu option is selected when you need to pair an optional wireless headset or the All Road PTT Button, or to view or change the audio path.

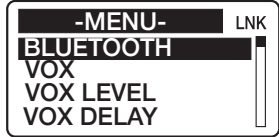

Pairing a Bluetooth® Headset:

While optional, wearing a compatible headset when driving and using the 75 All Road will further enhance its noise canceling feature.

Instructions:

1. Disable Bluetooth® on your phone then put your Bluetooth® headset into pairing mode (refer to your headset instructions).
2. Scan for a new Bluetooth® device in the 75 All Road Handset MENU>>BLUETOOTH>>PAIR>>HEADSET>>SCAN DEVICE.
3. A pop-up window appears displaying "SEEKING HEADSET".
4. The Bluetooth® headset will automatically pair to the 75 All Road CB.

NOTE: Re-enable Bluetooth® on your phone for use with the headset for incoming/outgoing calls.

Transmitting options while using your Bluetooth® headset:

1. **Through the 75 All Road Handset** (use the PTT button and speak into the headset microphone), or
2. **With the All Road Wireless Push-to-Talk Button** (sold separately). The All Road Wireless Push-to-Talk Button can be purchased online at cobra.com.

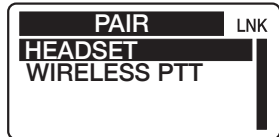

NOTE: The 75 All Road does not pair to a smartphone. If you want to use your Bluetooth® headset with both a smartphone and the 75 All Road CB, your headset must support "multi-point" (or pair with two devices at one time).

NOTE: Your 75 All Road is connected via Bluetooth® with the handset and transceiver (black box) and paired out of the box. It will not need to be re-paired unless you need to reconnect the handset or reset the connection.

Pairing All Road Wireless PTT Button:

The 75 All Road is designed to work with the Cobra All Road Wireless Push-to-Talk Button (sold separately) to communicate while wearing a Bluetooth® headset. It can also be a hands-free option while using the CB.

A velcro strap is included for convenient mounting.

Pairing Instructions:

1. Push and release the PTT Button to initiate the pairing process.
2. Connect to the PTT button from the All Road Handset: MENU>>BLUETOOTH>>PAIR>>WIRELESS PTT>>PAIR.
3. A pop-up window displays "Pair to Wireless PTT" when in range.
4. The wireless PTT button will automatically pair to the 75 All Road CB.

NOTE: Only the All Road Wireless PTT Button will work with the 75 All Road CB for a handsfree or remote PTT solution.

Questions or Need Help? Please call Cobra Customer Care at 800-543-1608.



Audio Path

AUDIO PATH shows the Bluetooth® connection of the device the audio is being routed to. There are two audio paths in which sound can be routed from the All Road:

1. Handset
2. Headset

The audio path which the radio is operating can easily be identified on the display:

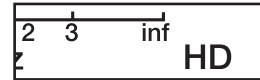

Out of the box, the audio source will be coming from the connected All Road handset and you will see an "HD" icon on the display under the Channel number.

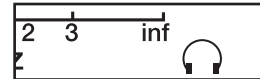

If you connect the All Road to a wireless headset, this changes the audio path and you will see an **Headset icon** appear under the Channel number.

To view, change or verify which audio path you are operating:

1. Press and hold the ENT/MENU button on the All Road handset to activate the MENU
2. **Select BLUETOOTH>>AUDIO PATH** from the Menu options by pressing ENT
3. You will see a "check mark" to the left of the audio path connected

NOTE: There may be an instance you will need to change the audio path. To do so, use the UP or DOWN arrow buttons to change the audio path and press ENT to select.

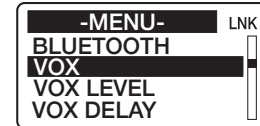

VOX (ON/OFF)

VOX enables voice activated transmission and hands-free usage.* When VOX is enabled, the 75 All Road will automatically start transmitting when your voice is heard and will stop when you finish talking. VOX is useful while driving to communicate without needing to hold the All Road handset or in situations where you need to keep both hands on

the wheel. To enable/disable VOX:

1. Press and hold the MENU button
2. Select VOX from the MENU options
3. Use the UP or DOWN arrow to enable VOX ON or to turn VOX OFF
4. Use the ESC button to get back to the home screen or go VOX LEVEL and VOX DELAY Menu options to adjust the VOX trigger and hang time levels.

* Requires the All Road Wireless PTT Button (sold separately) to talk hands-free

NOTE: VOX can be triggered from high background noise levels. In this case, use normal PTT (from the handset or All Road Wireless PTT Button) to control transmission.

NOTE: VOX will not work with a wireless headset and can only be used with the All Road handset.



Menus

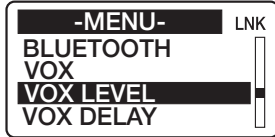

VOX Level (Level 01 - 09)

VOX Level sets the trigger point for VOX. The higher the level, the louder your voice needs to be to trigger VOX. To set the VOX level:

1. **Enable VOX** (see "VOX" instructions)
2. **Press and hold the ENT/MENU button** on the All Road handset to activate the MENU
3. **Use the DOWN arrow key to select VOX LEVEL** from the Menu Options
4. Use the ESC button to get back to the home screen



VOX Delay (Level 01 - 09)

VOX Delay sets the transmitter ON or "hang time" after the user stops speaking into the microphone. This setting is measured in seconds and can be tailored to adjust the amount of time the transmitter hangs in between speaking. The higher the setting, the longer the hang time. To adjust VOX DELAY:

1. **Enable VOX** (see "VOX" instructions)
2. **Press and hold the ENT/MENU button** on the All Road handset to activate the MENU
3. **Use the DOWN arrow key to select VOX DELAY** from the Menu Options
4. **Adjust VOX DELAY (01 - 09) using the UP or DOWN arrow keys** and select ENT (Enter) to select
5. Use the ESC button to get back to the home screen

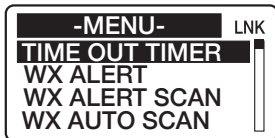

Time Out Timer (OFF - Level 10)

The transmitter Time Out Timer sets the amount of time in minutes that the transmitter is allowed to operate continuously. This feature helps to minimize interference to the CB channel in the event of an unintended transmission such as a 'stuck' PTT switch. Setting Time Out Timer:

1. Press and hold the ENT/MENU button on the All Road handset to activate the MENU
2. **Use the DOWN arrow to select TIME OUT TIMER** from the Menu options
3. **Adjust TIME OUT TIMER (OFF - 10) using the UP or DOWN arrows** and select ENT (Enter) to select
4. Use the ESC button to get back to the home screen



Menus

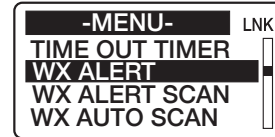

WX Alert (ON / OFF)

When WX (or Weather) Alert is enabled, it will make an alert sound when it picks up a 1050 Hz tone from the National Weather Service. The weather receiver must be set to an active weather station for the 1050 Hz tone to sound. To enable/disable Weather Alerts:

Instructions:

1. Press the WX button on the handset to **go into Weather Mode and select an active (local) weather station**
2. **Press and hold the ENT/MENU button** on the All Road handset to activate the MENU
3. **Use the DOWN arrow to select WX ALERT** from the Menu options
4. **Use the UP or DOWN arrow to select ON or OFF**, press ENT to enable
5. Go back to CB Mode by pressing ESC until you get to the home screen, then press the CB/WX button on the handset to change between CB and Weather (WX) modes



WX Alert Scan (ON / OFF)

WX AUTO SCAN when enabled will look for and lock on to the strongest weather station signal. This happens in the background and is useful for cross-country travel. How it works: WX AUTO SCAN locks onto a local NWS and can be accessed when you switch over to WX mode (by press the CB/WS button on the handset). To enable/disable Weather Alert Scanning:

1. **Press and hold the ENT/MENU button** on the All Road handset to activate the MENU
2. **Select WX ALERT SCAN** from the Menu Options
3. **Use the UP or DOWN arrow to select ON or OFF**, press ENT to select
4. Press the ESC button to get back to the home screen



WX Auto Scan (ON / OFF)

WX AUTO SCAN when enabled will look for and lock on to the strongest weather station signal. This happens in the background and is useful for cross-country travel. To enable/disable WX AUTO SCAN:

1. Press and hold the ENT/MENU button on the All Road handset to activate the MENU
2. Select WX AUTO SCAN from the Menu Options
3. Use the UP or DOWN arrow to select ON or OFF, press ENT to select
4. Press the ESC button to get back to the home screen

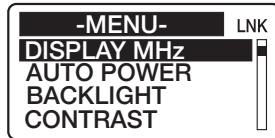

Display MHz (ON / OFF)

Displays the frequency of the current CB or weather channel. To turn DISPLAY MHz ON or OFF:

1. Press and hold the ENT/MENU button on the All Road handset to activate the MENU
2. Use the DOWN arrow to DISPLAY MHz from the Menu Options
3. Use the UP or DOWN arrow to select ON or OFF, press ENT to select
4. Press the ESC button to get back to the home screen



Auto Power (ON / OFF)

When Auto Power is enabled, it allows the radio to turn itself on when power is restored from the vehicle. When AUTO POWER is set to OFF, the radio will need to be manually powered ON when the vehicle is started up. To adjust the AUTO POWER setting:

1. Press and hold the ENT/MENU button on the All Road handset to activate the MENU
2. Use the DOWN arrow to select AUTO POWER from the Menu Options
3. Use the UP or DOWN arrow to select ON or OFF, press ENT to select
4. Press the ESC button to get back to the home screen

NOTE: This feature only works if the radio is left ON when the vehicle is turned off. If the radio is OFF when power is cut from the radio (when you turn your vehicle off), your radio will not automatically turn ON, even when AUTO POWER is enabled.



Backlight (OFF - High)

The purpose of display backlight is to increase readability. To adjust the backlight:

1. Press and hold the ENT/MENU button on the All Road handset to activate the MENU
2. Use the DOWN arrow to select BACKLIGHT from the Menu Options
3. Use the UP or DOWN arrow to increase or decrease the backlight, press ENT to select
4. Press the ESC button to get back to the home screen



Contrast (OFF - High)

Contrast adjusts the brightness of the backlight. To find the right contrast setting:

1. Press and hold the ENT/MENU button on the All Road handset to activate the MENU
2. Use the DOWN arrow to select CONTRAST from the Menu Options
3. Use the UP or DOWN arrow to increase or decrease the contrast, press ENT to select
4. Press the ESC button to get back to the home screen



Key Tone (ON / OFF)

KEY TONE is an option to have key tone sounds when the buttons are pressed. To enable/disable:

Instructions:

1. Press and hold the ENT/MENU button on the All Road handset to activate the MENU
2. Use the DOWN arrow to select KEY TONE from the Menu Options
3. Use the UP or DOWN arrow to turn ON or OFF, press ENT to select
4. Press the ESC button to get back to the home screen

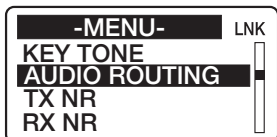

Audio Routing

AUDIO ROUTING determines where receiver audio can be heard. There are 3 options:

1. **BT SPK ONLY** - sound will come from the handset or wireless headset
2. **EXT SPK ONLY** - sound will come from an optional external speaker (sold separately and requires additional installation)
3. **BT & EXT** - sound will be routed from the handset or wireless headset + an external speaker (at the same time)

You will only change this setting for options 2 and 3 (your All Road defaults to option 1). To change audio routing:

1. **Press and hold the ENT/MENU button** on the All Road handset to active the MENU
2. **Use the DOWN arrow to select AUDIO ROUTING** from the Menu Options
3. **Use the UP or DOWN buttons select the audio path**, press ENT to select
4. Press the ESC button to get back to the home screen

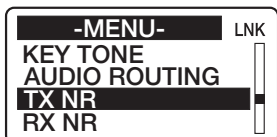

TX NR (OFF - Level 05)

TX NR stands for Transmitter Noise Reduction and is a Digital Signal Processing feature of this radio. Enabling this feature will help further reduce background noise that the Handset microphone will pick up in a typical moving vehicle and send to the person on the other end. For the person on the receiving end, they will be able to hear your voice transmission more clearly from the All Road.

For transmit noise reduction, the higher the level the greater the noise reduction. This should be used depending on the environment (noise level inside the vehicle). In a quiet environment, TX NR (or DSP) is not needed. To adjust Transmit DSP:

1. **Press and hold the ENT/MENU button** on the All Road handset to active the MENU
2. **Use the UP button to select TX NR** from the Menu Options
3. **Use the UP or DOWN buttons select the Transmit DSP level**, press ENT to select
4. Press the ESC button to get back to the home screen

NOTE: Use TX NR setting to help reduce the background noise for better speech intelligibility at the other CB radio station.



RX NR (OFF - Level 05)

RX NR stands for Receiver Noise Reduction. Enabling this feature will help to reduce radio noise sources picked up by the All Road receiver and improve the ability to clearly hear the voice of the person transmitting from the other end. RX NR works differently than TX NR where RX noise is environmentally created as a result of band conditions resulting in a lower signal-to-noise ratio, reducing speech intelligibility. Adjusting RX NR or Receiver DSP will help to improve speech intelligibility and increase the signal to noise ratio that can greatly enhance the CB radio two-way communications experience. To adjust RX DSP:

1. **Press and hold the ENT/MENU button** on the All Road handset to active the MENU
2. **Use the UP button to select RX NR** from the Menu Options
3. **Use the UP or DOWN buttons select the Receive DSP level**, press ENT to select
4. Press the ESC button to get back to the home screen

NOTE: The level of DSP selected is based on personal preferences. Start on level 1 setting and listen to the current activity on the selected CB channel. If needed, increase the DSP level until an optimum setting is achieved or as desired. There are times when the CB band is fairly quiet. In those instances it may be more desirable to disable RX NR.

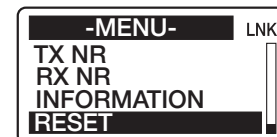

Reset (YES / NO)

RESET restores the 75 All Road factory to default settings. To reset the 75 All Road:

1. **Press and hold the ENT/MENU button** on the All Road handset to active the MENU
2. **Use the UP button to select RESET** from the Menu Options
3. **Select YES using the UP or DOWN button, press ENT to select**
4. **"RESET CB" appears.** Select YES using the UP or DOWN arrow button, press ENT to select
5. **"RESET CB PLEASE WAIT" appears** and the 75 All Road CB is reset to its original settings



Frequency Ranges

This unit features advanced Phase Lock Loop (PLL) circuitry providing complete coverage of all 40 CB channels.

Mode	CB Channel	Channel Frequency in MHz	Mode	CB Channel	Channel Frequency in MHz
AM/FM	1	26.965	AM/FM	21	27.215
AM/FM	2	26.975	AM/FM	22	27.225
AM/FM	3	26.985	AM/FM	23	27.255
AM/FM	4	27.005	AM/FM	24	27.235
AM/FM	5	27.015	AM/FM	25	27.245
AM/FM	6	27.025	AM/FM	26	27.265
AM/FM	7	27.035	AM/FM	27	27.275
AM/FM	8	27.055	AM/FM	28	27.285
AM/FM	9	27.065	AM/FM	29	27.295
AM/FM	10	27.075	AM/FM	30	27.305
AM/FM	11	27.085	AM/FM	31	27.315
AM/FM	12	27.105	AM/FM	32	27.325
AM/FM	13	27.115	AM/FM	33	27.335
AM/FM	14	27.125	AM/FM	34	27.345
AM/FM	15	27.135	AM/FM	35	27.355
AM/FM	16	27.155	AM/FM	36	27.365
AM/FM	17	27.165	AM/FM	37	27.375
AM/FM	18	27.175	AM/FM	38	27.385
AM/FM	19	27.185	AM/FM	39	27.395
AM/FM	20	27.205	AM/FM	40	27.405

NOTE: All 40 channels support AM and FM operating modes.



Specifications

General	
Channels	CB - 40 CH AM and FM
Frequency Range	CB – 26.965 to 27.405 MHz
Frequency Tolerance	0.005 %
Frequency Control	PLL (Phase Lock Loop) Synthesizer
Operating Temperature Range	-30° C TO + 65° C
Microphone	Plug-in Condenser
Input Voltage	13.8VDC nom. (negative ground)
Current Drain	Transmit: AM / FM mod., 1.4A (Maximum) Receive: Squelched, 0.9 A; full audio output, 1.2A (nominal)
Size	.98"H x 4.37"W x 4.09"D
Weight	.66 lbs. (1.37 lbs. in package)
Antenna Connector	UHF; SO-239
Fuse	DC power cord inline fuse holder contains the following fuse type: F2AL 125V - UL rated. 12V accessory charging cord contains the following fuse type: F2AL 125V - UL rated.
Transmitter	
Power Output	4 watts
Modulation	AM (Amplitude Modulation) FM (Frequency Modulation)
Frequency Response	300 to 3000 Hz
Output Impedance	50 ohms, unbalanced
Receiver	
Sensitivity	AM - Less than 1uV for 10dB (S+N) FM - -120dBm @ 12 dB SINAD)
Selectivity	6 dB @ 7 KHz, 60 dB @ 10KHz
Image Rejection	60 dB, typical
Adjacent-Channel Rejection	50 dB, typical
Automatic Noise Limiter	Built-in



Maintenance/Adjustment

Your Cobra CB transceiver is specifically designed for the environment encountered in mobile installations. The use of all solid state circuitry and its light weight result in high reliability. Should a failure occur, however, review the following, then if necessary, replace parts with identical parts. Substitution is not recommended. If you have questions, please call Cobra Customer Care at 800-543-1608 (hours are listed on the Cobra.com website).

1. Check connections to the source of power and make sure it is the 13.8 VDC required to operate your radio.
2. Check Bluetooth® connection and be sure headset and transceiver are paired.
3. Check the fuses in the DC power cord and in the 12V accessory power plug. The main power lead (red) has a 2 Amp fuse - type F2AL 125V - UL rated in its holder. Use only the above specified type and size fuse for maximum protection. Failure to do so will void the warranty.
4. Make certain the microphone is properly plugged in.
5. Make certain the antenna is properly assembled and connected. If you are unable to correct the problem, please contact Cobra customer service.



Troubleshooting

Problem:	Recommended Action(s):
When streaming or taking a phone call from my headset, I hear static.	<ul style="list-style-type: none"> - Turn the volume on the All Road OFF, or - Adjust the Squelch to the maximum level using the handset (press the SQ/ASQ button).
Why can't I hear anything coming out of my headset?	<ul style="list-style-type: none"> - Pair your headset to the All Road. - Check the Audio Path (through All Road Menu).
I cannot disconnect my headset from the All Road.	<ul style="list-style-type: none"> - Disconnect through the Menu on the handset: Press ENT/MENU>>BLUETOOTH>>PAIR>>HEADSET>>DISCONNECT.
I answer a phone call on my SmartPhone and hear no sound. I am not using the All Road or my wireless headset.	<ul style="list-style-type: none"> - Turn off Bluetooth on your Smartphone (headset may still be connected if in range).
I cannot Push-to-Talk with my multi-point headset when using the All Road.	<ul style="list-style-type: none"> - A headset requires an external PTT function which can be resolved by using the All Road handset or All Road wireless Push-to-Talk Button to communicate over your headset with the All Road CB.
The Handset continuously displays the Cobra Logo and not the normal CB radio.	<ul style="list-style-type: none"> - Disconnect power from the BlackBox unit. - Connect the Handset directly to the BlackBox USB port. - Re-connect 12V power to the BlackBox and push the Handset power button to turn ON the All Road (if needed). - The Handset will automatically pair and connect to the BlackBox and should boot to the CB radio function. - Power down the All Road and remove the Handset from the BlackBox USB port then use the All Road per the original installation and use case.

NOTE: A full list of Frequently Asked Questions can be found on the 75 All Road product page on cobra.com.



FCC Part 15.19 Warning Statement

THIS DEVICE COMPLIES WITH PART 15 OF THE FCC RULES. OPERATION IS SUBJECT TO THE FOLLOWING TWO CONDITIONS: (1) THIS DEVICE MAY NOT CAUSE HARMFUL INTERFERENCE, AND (2) THIS DEVICE MUST ACCEPT ANY INTERFERENCE RECEIVED, INCLUDING INTERFERENCE THAT MAY CAUSE UNDESIRE OPERATION.

FCC Part 15.21 Warning Statement-

NOTE: THE GRANTEE IS NOT RESPONSIBLE FOR ANY CHANGES OR MODIFICATIONS NOT EXPRESSLY APPROVED BY THE PARTY RESPONSIBLE FOR COMPLIANCE. SUCH MODIFICATIONS COULD VOID THE USER'S AUTHORITY TO OPERATE THE EQUIPMENT.

FCC Part 15.105(b) Warning Statement

NOTE: This equipment has been tested and found to comply with the limits for a Class B digital device, pursuant to part 15 of the FCC Rules. These limits are designed to provide reasonable protection against harmful interference in a residential installation. This equipment generates uses and can radiate radio frequency energy and, if not installed and used in accordance with the instructions, may cause harmful interference to radio communications. However, there is no guarantee that interference will not occur in a particular installation. If this equipment does cause harmful interference to radio or television reception, which can be determined by turning the equipment off and on, the user is encouraged to try to correct the interference by one or more of the following measures:

- Reorient or relocate the receiving antenna.
- Increase the separation between the equipment and receiver.
- Connect the equipment into an outlet on a circuit different from that to which the receiver is connected.
- Consult the dealer or an experienced radio/TV technician for help.

IC RSS-GEN, Sec 8.4 Warning Statement

ENGLISH: This device complies with Industry Canada license-exempt RSS standard(s). Operation is subject to the following two conditions: (1) this device may not cause interference, and (2) this device must accept any interference, including interference that may cause undesired operation of the device.

FRENCH: Le présent appareil est conforme aux CNR d'Industrie Canada applicables aux appareils radio exempts de licence. L'exploitation est autorisée aux deux conditions suivantes : (1) l'appareil ne doit pas produire de brouillage, et (2) l'utilisateur de l'appareil doit accepter tout brouillage radioélectrique subi, même si le brouillage est susceptible d'en compromettre le fonctionnement.

IC RSS-GEN, Sec 8.3 Warning Statement

ENGLISH: This radio transmitter (identify the device by certification number, or model number if Category II) has been approved by Industry Canada to operate with the antenna types listed below with the maximum permissible gain and required antenna impedance for each antenna type indicated. Antenna types not included in this list, having a gain greater than the maximum gain indicated for that type, are strictly prohibited for use with this device.

Immediately following the above notice, the manufacturer shall provide a list of all antenna types approved for use with the transmitter, indicating the maximum permissible antenna gain (in dBi) and required impedance for each.

FRENCH: Le présent émetteur radio (identifier le dispositif par son numéro de certification ou son numéro de modèle s'il fait partie du matériel de catégorie I) a été approuvé par Industrie Canada pour fonctionner avec les types d'antenne énumérés ci-dessous et ayant un gain admissible maximal et l'impédance requise pour chaque type d'antenne. Les types d'antenne non inclus dans cette liste, ou dont le gain est supérieur au gain maximal indiqué, sont strictement interdits pour l'exploitation de l'émetteur.

RF Exposure Statement

ENGLISH: This equipment complies with FCC radiation exposure limits set forth for an uncontrolled environment. This equipment should be installed and operated with minimum distance 40cm between the radiator & your body.

The device is in compliance with RF exposure guidelines, users can obtain Canadian information on RF exposure and compliance. The minimum distance from body to use the device is 40cm.

FRENCH: Cet équipement est conforme aux limites d'exposition aux rayonnements de la FCC établies pour un environnement non contrôlé. Cet équipement doit être installé et utilisé avec une distance minimale de 40 cm entre le radiateur et votre corps.

Après examen de ce matériel aux conformité ou aux limites d'intensité de champ RF, les utilisateurs peuvent sur l'exposition aux radiofréquences et compliance d'acquérir les informations correspondantes. La distance minimale du corps à utiliser le dispositif est de 40cm.

Product Exposure Statement

ENGLISH: Warning: The 75 All Road CB radio is for in-vehicle use only. It is not to be installed outside the intended vehicle of use. This includes the installation and operation of third-party Bluetooth devices such as a compatible headset paired and connected to the 75 All Road CB radio. Long term operation outside the vehicle may result in damage to the 75 All Road CB radio.

FRENCH: Avertissement : La radio 75 All Road CB est destinée à une utilisation en véhicule uniquement. Il ne doit pas être installé en dehors du véhicule d'utilisation prévu. Cela inclut l'installation et le fonctionnement d'appareils Bluetooth tiers tels qu'un casque compatible couplé et connecté à la radio 75 All Road CB. Une utilisation à long terme à l'extérieur du véhicule peut endommager la radio 75 All Road CB.



Limited Two-Year Warranty

Warranty Terms:

Cobra warrants your product against all defects in materials and workmanship for a period of two (2) years from the date of original purchase.

Cobra, at our sole discretion, will repair or replace your product (with the same or comparable product) free of charge.

Cobra will not pay shipping charges that you incur for sending your product to us. Products received COD will be refused.

To make a warranty claim, we will require proof or purchase in the form of an invoice or receipt. No proof of purchase is required for factory direct purchases.

Warranty Exclusions: Warranty does not apply to your product under any of the following conditions:

1. The serial number has been removed or modified.
2. Your product has been subjected to misuse or damage (including water damage, physical abuse, and/or improper installation).
3. Your product has been modified in any way.
4. Your receipt or proof-of-purchase is from a non-authorized dealer or internet auction site including E-bay, U-bid, or other non-authorized resellers.

LIMITATION OF WARRANTY: EXCEPT AS EXPRESSLY PROVIDED HEREIN, YOU ARE ACQUIRING THE PRODUCT "AS IS" AND "WHERE IS", WITHOUT REPRESENTATION OR WARRANTY. COBRA SPECIFICALLY DISCLAIMS ANY REPRESENTATION OR WARRANTY INCLUDING, BUT NOT LIMITED TO THOSE CONCERNING THE MERCHANTABILITY AND SUITABILITY OF THE PRODUCT FOR A PARTICULAR PURPOSE. COBRA SHALL NOT BE LIABLE FOR CONSEQUENTIAL, SPECIAL OR INCIDENTAL DAMAGES INCLUDING, WITHOUT LIMITATION, DAMAGES ARISING OUT OF THE USE, MISUSE OR MOUNTING OF THE PRODUCT.

The above limitations or exclusions shall be limited to the extent they violate the laws of any particular state. Cobra is not responsible for products lost in shipment between the owner and our service center.

General Warranty Information

Each product we manufacture is covered by our factory warranty. While each product may have unique components and policy, the general guideline below will apply to most Cobra products.

All Cobra products purchased factory-direct or from our Authorized Resellers will come with a full one to three (1-3) year warranty from the date of the original retail purchase (see policy statement above for full warranty details and exclusions).

Standard accessories packaged with each model will have a one-year factory warranty.

Accessory items have a one-year factory warranty.

Shipping to our facility is not covered in our warranty. Return shipping is included within the US.











This warranty is non-transferrable.

For the sake of clarity, 'repair or replace the Product or its defective part' does not include removal or installation work, costs or expenses which include but are not limited to labor costs or expenses.

Cobra will not be responsible for lost packages.



Replacement Parts & Accessories

	PART/MODEL #	CONTAINS
	CCBA75HSR1 HANDSET	All Road Handset
	CCBABPT01 ALL ROAD WIRELESS PTT BUTTON	(1) All Road Wireless Push-to-Talk Button w/ Velcro strap and power cord
	CCBAPTTS1 WIRELESS PTT BUTTON VELCRO STRAP	(1) strap for the All Road Wireless PTT Button
	CCBA12VA01 12V CLA ACCESSORY	12 Volt adapter with USB (for connection with the All Road Handset)
	CCBAMHR01 MICROPHONE HANGER	Microphone Hanging Kit for All Road Handset
	CCBAMPR01 MICROPHONE POST	Replacement post for All Road Handset
	CCBAPTTC01 ALL ROAD PTT BUTTON REPLACEMENT POWER CORD	(1) Micro-USB charging cord for All Road PTT Button
	CCBABBR01 BLACK BOX MOUNTING	#2 Philipps, 3/4" Black chromate replacment screws
	CCBA75RP01 BLACK BOX USB COVER	Waterproof USB cover for the All Road USB port (located on the front of the black box)
	CCBA75HWK1 HARDWIRE KIT	48" hardwire with waterproof connector to All Road CB

Go to cobra.com for replacement parts and accessories.

Questions or Need Help? Please call Cobra Customer Care at 800-543-1608.



Need Help?

If you have any questions about operation or installing your new Cobra product, PLEASE CONTACT COBRA FIRST...do not return this product to any retail store.

The contact information for Cobra will vary depending on the country in which you purchased and utilize the product. For the latest contact information, please go to: www.cobra.com/support.

For products purchased in the U.S.A. you may call 800-543-1608.

For products purchased in the U.S.A., if your product should require factory service, please go to www.cobra.com/support and follow the instructions for returning your product to the Cobra Factory Service Department for service.

Should there be any problems with this product or further information is needed on its features please visit www.cobra.com for support, frequently asked questions, Declarations of Conformity, and full manuals.

For Products Purchased Outside the U.S.A. or Canada

Please contact your local dealer for product service information.