



danita[®] 340

Mobile CB Radio



USER'S MANUAL

1. KNOW ABOUT THIS RADIO

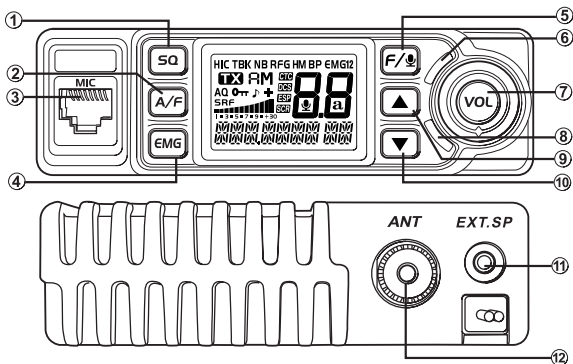

1	Squelch control, SQ, ASQ switch key
2	Mode/Keypad lock
3	Microphone Jack
4	Emergency channel
5	Functions
6	TX indicator
7	Power On/Off Volume control
8	RX indicator
9	Channel up selector
10	Channel down selector
11	External speaker Jack
12	Antenna Jack

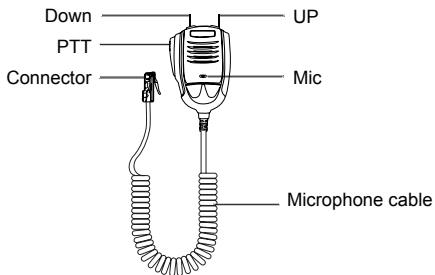

2. LCD

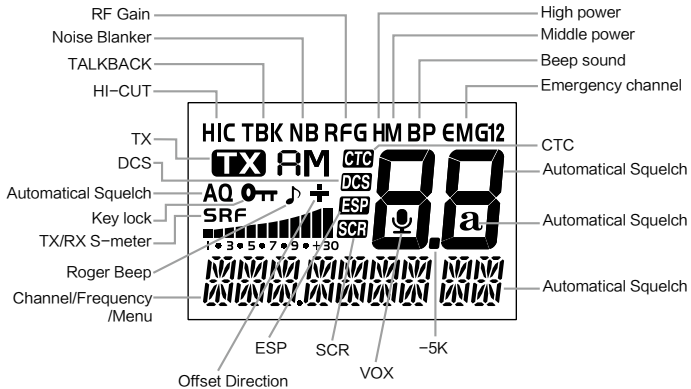

Function and Features

1. AM/FM/PA MODE
2. 7 COLOR DISPLAY
3. VOX FUNCTIONS(TRANSMIT WITHOUT PRESS PTT)
4. SQ, ASQ FUNCTION
5. RF GAIN FUNCTION
6. SCAN FUNCTION
7. RB FUNCTION
8. NB FUNCTION
9. DUAL-WATCH FUNCTION
10. BEEP SOUND
11. TOT FUNCTION
12. HI-CUT FUNCTION
13. EMG CALL
14. SUIT DYMATIC AND ELECTRONIC MICROPHONE
15. BACKLIGHT BRIGHTLESS ADJUSTABLE
16. -5KHZ FUNCTION
17. OFFSET FUNCTION
18. KEY LOCK FUNCTION
19. CTCSS/DCS CODE(OPTIONAL)
20. BUILT IN 12/24V CONVERTOR(OPTIONA)

3. HOW TO USE THIS RADIO

3.1 Power On/Off the Radio

- (1) Turn VOL switch clockwise to power on the radio, the LCD displays the Norms and then displays channel number.
- (2) Turn VOL switch anti-clockwise, until hear Ka Ta, the radio is powered off.

3.2 Volume Control

Turn clockwise to increase volume, anti-clockwise to decrease volume.

3.3 Channel Control

- (1) Short press microphone [UP] or [DN] to change working channel.
- (2) Long press microphone [UP] or [DN] can fast change working channel.

3.4 **sq**

※ Squelch level Control (short press)

- (1) Short press **sq** , until LCD displays "SQLSET 00", "00" stands for SQ level, the bigger value stands for high squelch level.
- (2) Short press microphone [UP] or [DN] to change SQ level.
- (3) Long press microphone [UP] or [DN] can fast change SQ level.
- (4) Short press **sq** or wait for 10 seconds to store and exit.

Note: *The higher SQ level selected, the stronger signal required to open speaker and hear the calling.*

※ ASQ Control (long press)

- (1) Long press **sq** , until LCD displays "AQ", the ASQ function turned on.
- (2) Short press **sq** , until LCD displays "ASQSET 06", "06" stands for ASQ level, the bigger value stands for high squelch level.
- (3) Short press microphone [UP] or [DN] to change ASQ level.
- (4) Long press microphone [UP] or [DN] can fast change ASQ level.
- (5) Short press **sq** or wait for 10 seconds to store and exit.
- (6) Long press **sq** key again to turn on SQL function.



Note: *The higher ASQ level selected, the stronger signal required to open speaker and hear the calling.*

3.5

※Mode Control (short press)

- (1) Short press , key to switch between **FM/FM** mode.
- (2) The LCD displays the selected mode.



※Keypad Lock (long press)

- (1) Long press  key for over 2 seconds to lock the keys, LCD displays **0TT**.
- (2) Long press  key for over 2 seconds again to unlock the keys **0TT** disappears from LCD.

Note: In lock Mode all keys except PTT is valid.

3.6

※Emergency Channel (short press)

- (1) First press , key to choose the first programmed emergency channel, LCD displays **EMG**.
- (2) Second press , key to choose the second programmed emergency channel.
- (3) Third press , key to return to last normal channel, EMG disappears from LCD.

Note: The default emergency channel are channel 9 and channel 19.

See menus Emergency Channel Set page 8 for the emergency channel configuration.

3.8



※Scan Function (short press)

- (1) Hold UP or Down key for over 5 seconds and release the key when hear "Di" beep sound to start scan, "SCAN" flashes in the LCD.
- (2) Short press UP or Down key to change scan direction.
- (3) Short press AM/FM to change scan mode, short press [EMG] or [PTT] to exit scan.

3.9

※VOX function

The VOX function allows transmitting by speaking into the original microphone without pressing the [PTT] switch.



Press [PTT] +  key to activate VOX function, LCD displays microphone icon "", and then press [PTT] +  key to disable VOX function. The microphone icon disappeared.

Note: When VOX is turned on, the microphone symbol flashes in LCD.

※Talkback Level

This function allows you to adjust the volume of your walkie-talkie.

(1) Start the intercom function (see "intercom" on page 8).

(2) Hold down the [PTT] switch, then the  key increases or the  key decreases the Talkback Level.

(3) Release [PTT] switch and save Talkback Level.

※Functions (long press)

Long press  key to enter in menu and set different function.

※Norms Control

(1) Hold  to power on radio, until LCD displays the norms.

(2) Short press microphone [UP] or [DN] to choose wanted norms.



(3) Power off and power on again.

3.10 Install External Speaker



Choose a 8 Ω external speaker with 3.5mm mono connector.

3.11 Menu Operations

(1) Long press  key to enter menu list.

(2) Short press microphone [UP] or [DN] or  or  to choose menu to be.

(3) Short press  key to enter function setting parameter of the chosen function, the parameter blinks on LCD.

(4) Short press microphone [UP] or [DN] or  or  to choose wanted setting.

(5) Short press **[F/⏏]** key to validate the mode and exit setting.

(6) Long press **[F/⏏]** key or wait 20 seconds to store exit MENU.

NO.	LCD display	Function detail	Setting details
1	CUT.SET 0F		
2	KEY.BP ON	Beep sound	ON: turn on beep sound OFF: turn off beep sound Default: ON
3	MIC.SET 06		
4	MIC.TP EL		
5	VOXL 03		
6	VOX.T 04		
7	SQ.L.SET 08	Squelch level control	OFF, 1~34 Default: 8
8	ASQ.SET 06	Auto squelch level control	Level 1~9 Default: 6
9	SCA.TYPE TI	Scan type setting	SQ: squelch scan TI: time scan Default: SQ
10	HI.CUT 0F	HI-CUT setting	OFF: turn off HI-CUT function ON: turn on HI-CUT function Default: OFF

NO.	LCD display	Function detail	Setting details
11	TALKBACK OFF	Talkback level control	OFF, 1~9 Default: OFF
12	NBLANK OFF	Noise blanker	OFF: turn off NBLANK function ON: turn on NBLANK function Default: OFF
13	RF AUTO ON	Auto RF gain setting	OFF: turn off AUTO RF GAIN function ON: turn on AUTO RF GAIN function Default: ON
14	RF GAIN OFF	RF gain level control	Level 3、6、9~48 Default: 48
15	RB OFF OFF	RB sound setting	OFF, 1-5 OFF: turn off RB sound function. Default: OFF
16	COLOR RE	Backlight color setting	RE: Red GR: Green BL: Blue CY: Cyan YE: Yellow PU: Purple WH: White Default: RE
17	BRIGHT 06	Backlight brightness	Level 1~6 Default: 6
18	TOT SET 02	Time out timer	OFF, 1~10Min Default: 2
19	EMG ₁ EUL ₁ 09		
20	EMG ₂ EUL ₂ 19		

3.12 Band Name Setting

- (1) Choose a band to be modified.
- (2) Long press **[F/Ⓜ]** key to enter menu list.
- (3) Short press microphone **[UP]** or **[DN]** or **[▲]** or **[▼]** to choose NO.17 function memu, LCD displays **BN,NAME EU,EU** stands for current band name.
- (4) Short press **[F/Ⓜ]** key, the first digit blinks on LCD.
- (5) Short press microphone **[UP]** or **[DN]** or **[▲]** or **[▼]** to choose the character of the first digit.
- (6) Short press **[F/Ⓜ]** key to validate the first digit. The second digit blinks on LCD.
- (7) Short press microphone **[UP]** or **[DN]** or **[▲]** or **[▼]** to choose the character of the second digit.
- (8) Short press **[F/Ⓜ]** key to validate the second digit and exit setting.
- (9) Long press **[F/Ⓜ]** key or wait 20 seconds to store exit MENU.

3.13 Emergency Channel Setting

- (1) Long press **[F/Ⓜ]** key to enter menu list.
- (2) Short press microphone **[UP]** or **[DN]** or **[▲]** or **[▼]** to choose NO.18 function memu or NO.19 function memu, LCD displays **EMG.1 0000** or **EMG.2 0000**.
- (3) Short press **[F/Ⓜ]** key, the number "1" or number "2" blinks on LCD.
- (4) Short press microphone **[UP]** or **[DN]** or **[▲]** or **[▼]** to choose the emergency channel is valid.
OFF: stands for turn off current emergency channel.
- (5) Short press **[F/Ⓜ]** key, the band name blinks on LCD.
- (6) Short press microphone **[UP]** or **[DN]** or **[▲]** or **[▼]** to choose the frequency band.

Note: *This frequency band selection is valid only when the radio work in HF model or HAM model.*

- (7) Short press **[F/⏏]** key to validate the frequency band, and the channel blinks on LCD.
- (8) Short press microphone [**UP**] or [**DN**] or **[▲]** or **[▼]** to choose the channel.
- (9) Short press **[F/⏏]** key to validate the channel, and the mode blinks on LCD.
- (10) Short press microphone [**UP**] or [**DN**] or **[▲]** or **[▼]** to choose the mode AM or FM.
- (11) Short press **[F/⏏]** key to validate the mode and exit setting.
- (12) Long press **[F/⏏]** key or wait 20 seconds to store exit MENU.

Note: *Choose the frequency band is valid only when the radio work in HF model or HAM model.*

3.14 Resume Factory Default

- (1) Long press **[F/⏏]** key to enter menu list.
- (2) Short press microphone [**UP**] or [**DN**] or **[▲]** or **[▼]** to choose NO.20 function menu, LCD displays *RESET*.
- (3) Short press **[F/⏏]** key to enter menu selection, *RESET* flashes in the LCD.
- (4) Long press **[F/⏏]** key until LCD only displays *RESET*.
- (5) Release **[F/⏏]** key, the radio automatically reseted.

4. SPECIFICATION

GENERAL		
Modulation Mode	AM/FM	
Frequency Range	26.565–27.99125MHz	
Frequency Tolerance	± 5.0ppm	
Input Voltage	12V	
Dimensions	124x101x36mm	
Weight	428g	
Operating Temperature Range	–20°C to +50°C	
Current Drain	Transmit	3A MAX
	Receive	Squelched 0.3A
	VOL Max	0.7A
Antenna Connector	UHF, SO–239	
TRANSMITTER		
Power Output	4 Watts FM/AM	
Transmission interference	inferior to 4nW	
Frequency Response	300–3000Hz	
Modulated signal distortion	inferior to 5%	
Output Impedance	50 ohms	
RECEIVER		
Sensitivity	Less than 1uV for 10dB(S+N)/N	
Image Rejection	70dB	
Adjacent Channel Rejection	60dB	
IF Frequencies	1st 10.695MHz	
	2nd 455KHz	
Automatic Gain Control(AGC)	Less than 10dB change in audio	
	Output for inputs from 10 to 50000uV	
Squelch	less than 1uV	
Audio Output Power	1Watts at 8Ω less than 10% distortion	
Frequency Response	300–3000Hz	